



CP100

Commercial Series
Two-Way Radio User Guide

Table of Contents

Product Safety and RF Exposure Compliance	i
Introduction	1
FCC Licensing Information	3
Getting Started	5
Installing the Swivel Belt Holster	5
Installing the Nickel-Metal Hydride Battery	6
Charging the CP100 Radio	7
Turning Your Radio On or Off	8
Adjusting the Volume	8
Using the Radio	8
Understanding the Display	10
Battery and Charging Options ..	11
NiMH Battery.....	11
Alkaline Batteries	11
Charging with the Drop-in Charging Tray (NNTN4019)...	12
Reading the Battery Meter	13
Battery Life.....	13
CP100 Factory Defaults	14

Talking and Receiving	15
Signal Strength Indicator/Channel Busy	15
Talk Range	15
Keypad Lock.....	16
Hands-Free Use/VOX	16
With Compatible VOX Accessories.....	16
Without Accessories.....	17
Setting VOX Sensitivity	17
Monitoring a Channel	18
Scanning (15 ch models only) ..	18
Programming Features	20
Entering Programming Mode ...	20
Programming a Channel (15 ch models only).....	21
Programming the Frequency....	21
Programming the Interference Eliminator Code.....	22
Assigning Channels to Presets (15 Ch Models Only)	22
Programming the Scramble Feature.....	23
Programming Bandwidth (when FCC allowable).....	23

Programming the Available Channel (15 Ch Models Only)	24
Programming Call Tones	24
Programming Microphone Gain	25
Editing the Scan List (15 Ch Models Only)	26
Cloning	26
Advanced Features	28
Troubleshooting	30
Use and Care	33
Frequencies and Bandwidths...	34
Verifying the SP21 Radio Frequency and Code Setting	40
Motorola Limited Warranty	41
Software Copyright Notice	47
Patent Notice	47
Export Law Assurances	48
Replacement Parts	49

Product Safety and RF Exposure Compliance



Caution

Before using this product, read the operating instructions for safe usage contained in the Product Safety and RF Exposure booklet enclosed with your radio.

ATTENTION!

This radio is restricted to occupational use only to satisfy FCC RF energy exposure requirements. Before using this product, read the RF energy awareness information and operating instructions in the Product Safety and RF Exposure booklet enclosed with your radio (Motorola Publication part number 68P81095C98) to ensure compliance with RF energy exposure limits.

For a list of Motorola-approved antennas, batteries, and other accessories, visit the following web site which lists approved accessories: <http://www.motorola.com/cgiss/index.shtml>.

Introduction

Thank you for purchasing a Motorola CP100 Radio. Your radio is a product of Motorola's 70 plus years of experience as a world leader in the designing and manufacturing of communications equipment. The CP100 radios provide cost-effective communications for businesses such as retail stores, restaurants, schools, construction sites, manufacturing, property and hotel management and more. Motorola two-way radios are the perfect communications solution for all of today's fast-paced industries.

Note: Please read this manual carefully to ensure you know how to properly operate the radio before use.

Package Contents

- Radio
- Swivel Belt Holster
- NiMH Battery
- 10-Hour Charger
- User's Guide
- Accessory Brochure
- Warranty Card
- Drop-In Charging Tray (not included with all models)

For a copy of a large-print version of this guide, or for product-related questions, please contact:

1-800-927-2744 in the USA/Canada

1-888-390-6456 on your TTY (Text Telephone)

FCC Licensing Information

CP100 two-way radios operate on radio frequencies that are regulated by the Federal Communications Commission (FCC). In order to transmit on these frequencies, you are required to have a license issued by the FCC.

Application is made available on FCC Form 601 and Schedules D, H, and Remittance Form 159.

To obtain these FCC forms please request document **000601** which includes all forms and instructions. If you wish to have the document faxed, mailed or have questions, please use the following contact information.

Faxed contact the Fax-On- Demand system at:	Mailed call the FCC forms hotline at:	Questions regarding FCC license contact the FCC at:
1-202-418-0177	1-800-418-FORM 1-800-418-3676	1-888-CALL-FCC 1-888-225-5322 Or: http://www.fcc.gov

Before filling out your application, you must decide which frequency(ies) you can operate on. See Frequencies and Bandwidths.

For questions on determining your radio frequency, please call Motorola Product Services at: 1-800-927-2744.

Changes or modifications not expressly approved by Motorola may void the user's authority granted by the FCC to operate this radio and should not be made. To comply with FCC requirements, transmitter adjustments should be made only by or under the supervision of a person certified as technically qualified to perform transmitter maintenance and repairs in the private land mobile and fixed services as certified by an organization representative of the user of those services.

Replacement of any transmitter component (crystal, semiconductor, etc.) not authorized by the FCC equipment authorization for this radio could violate FCC rules.

Note: Use of this radio outside the country where it was intended to be distributed is subject to government regulations and may be prohibited.

Getting Started

This User's Guide covers several CP100 models, and may detail some features your radio does not have. Your model number is shown on the inside of the radio and can be seen by removing the battery.

Installing the Swivel Belt Holster

1. Slide the bottom of radio into the holster until it snaps into place.
2. To remove, push the tab above the battery door and pull the radio from holster.

Note: In case of loss, please contact your point-of-sale or call 1-800-422-4210 to request replacement part number NNTN4106.



NNTN4106 Swivel
Belt Holster

Installing the Nickel-Metal Hydride Battery

Your radio is powered by an NiMH battery, which provides up to 15 hours* of usage. Before you install the battery, mark the date in the "INSTALL DATE" section with a permanent marker. As in vehicles, all rechargable batteries lose capacity over time.

1. Push and hold down the ribbed latch on the bottom of the radio toward the contacts, then slide and lift the battery door off.
2. With the Motorola logo side up, and the charge contacts facing the bottom of the radio, insert the top of the battery into the radio.
3. Push the battery up and into the battery compartment to fit tightly into place.
4. Slide and snap the battery door into place.

*Based upon 5% transmit/ 5% receive/ 90% standby (standard duty cycle).

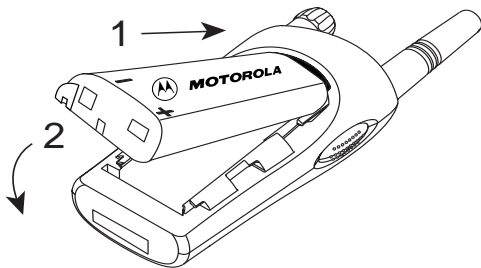
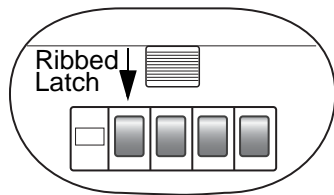

Charging the CP100 Radio

Charge the NiMH battery for 16 hours before using it for the first time. It will only need up to eight hours of charging thereafter.

1. Make sure the radio is off.
2. Lift the accessory cover and plug the charger (NNTN4077) into the lower jack.
3. Plug the charger into a power outlet. The light on the charger glows during charging.

Note: For optimum battery life, do not charge the battery for prolonged periods after it is fully charged. Charging the battery over the weekend is acceptable.

If the radio is on while charging, additional time is required to charge the battery.

Use only the charger supplied with the radio, or other CP100 power accessories. See “Battery and Charging Options” on page 11.

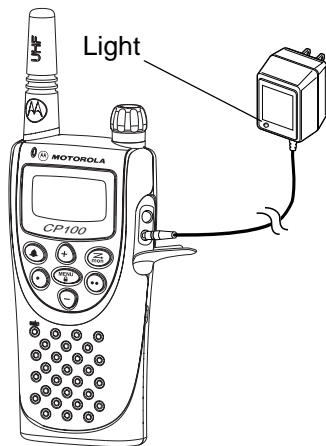

Turning Your Radio On or Off

Turn  clockwise for On or counterclockwise for Off.

The radio chirps and the display briefly shows all features and display segments of your CP100 radio.

Then the radio displays the current channel (larger number in the center) and the frequency assigned to that channel (on right).

The interference eliminator code displays briefly. Then the current channel remains displayed.

The transmit light on the front left of the radio flashes every three seconds when the radio is on.



Frequency





Code

Adjusting the Volume

You can set the volume by turning .

Note: Do not hold the radio too close to your ear when adjusting the volume or if it is at a high setting.

Using the Radio

1. Press and hold  to check for channel activity. If you hear static, the channel is clear to use. Do not transmit if someone is speaking on the channel. Press  again to stop monitoring the channel.
2. Press and hold  and speak into the microphone. To maximize clarity, hold the radio two-to-three inches away from your mouth.

Note: The transmit light on the front left of the radio lights red when transmitting.

3. Release  and listen for messages.

Basic Operation

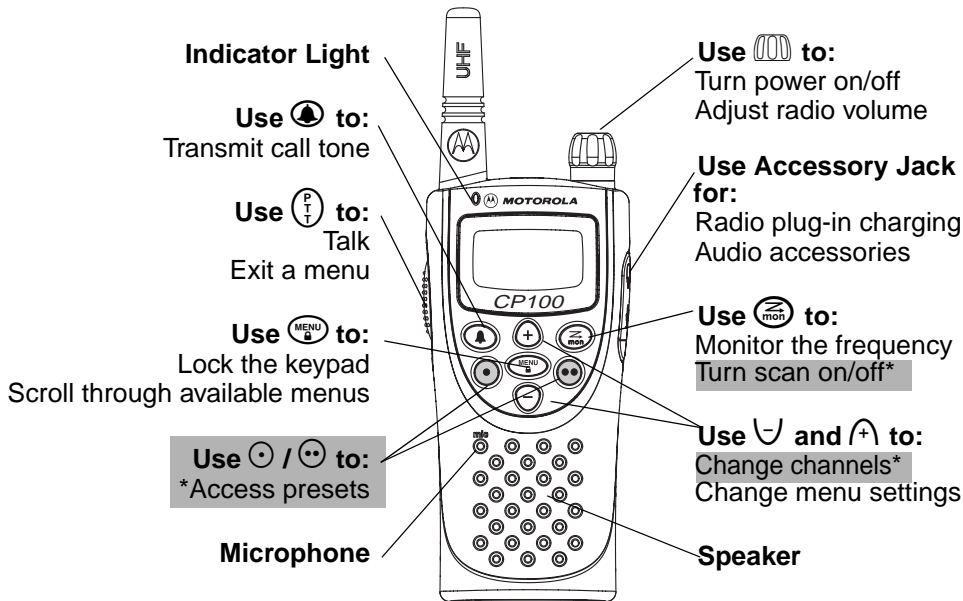

* 15 channel models only

Understanding the Display

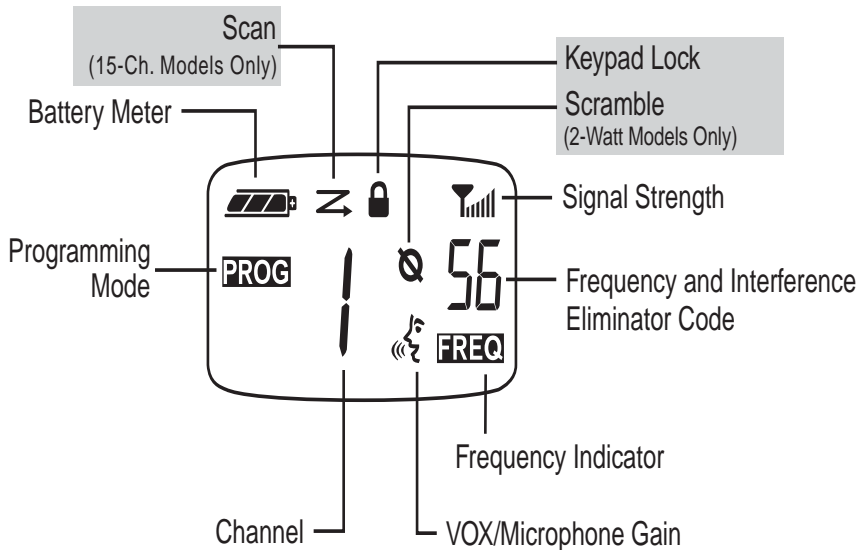

Battery and Charging Options

You have several battery and charging options on your CP100 Two-Way Radio.

NiMH Battery

See “Installing the Nickel-Metal Hydride Battery” on page 6.

Alkaline Batteries

Your radio can also use 4 AA batteries; alkaline cells provide up to 24 hours* of radio use.

1. Push the ribbed latch on the bottom of the radio away from the battery door.
2. Slide and lift the battery door off.
3. Place the AA batteries matching the markings in the compartment.
4. Slide and snap the battery door into place.
5. Press  until \bar{A} or n flashes.
6. Press \bar{A} or n to select \bar{A} for alkaline batteries, or n for rechargeable AA cells.

Note: This menu does not appear if the Motorola NiMH Battery is in use.

*Please refer to the diagram and Battery Life on page 13.

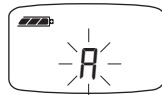

Charging with the Drop-in Charging Tray (NNTN4019)

(Not included with all models)

1. Place the drop-in charging tray on a flat surface.
2. Insert the plug of the 10-hour charger into the jack of the drop-in charging tray.
3. Plug the charger into a power outlet.

Insert the battery or radio into the tray with the Motorola logo or radio front facing the front of the charger and the contacts facing down.

Note: To extend battery life, do not overcharge. Charging the battery over the weekend is acceptable.

If the radio is on while charging, it will take longer to fully charge.

Use only the charger supplied with the radio, or other CP100 radio power accessories.



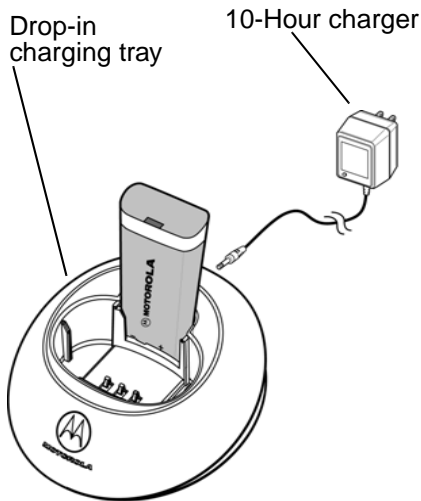

You can charge only one radio or battery at a time.

Tips: The radio can remain in the holster while charging.



Reading the Battery Meter

The battery meter located in the upper left corner of display indicates how much battery power you have remaining.



Battery Type	3 Bars	2 Bars	1 Bar	Flashing
				
NiMH	100%-85%	85%-25%	25%-10%	Final 10%
AA Alkaline	100%-75%	75%-40%	40%-10%	Final 10%

Battery Life

Watts	NiMH	Alkaline
2	13 Hours	22 Hours
1	15 Hours	24 Hours

CP100 Factory Defaults

Your CP100 radio is programmed at the factory. If you need to change settings, refer to Programming Features on page 20 and frequency list starting on page 34.

To restore your radio to factory default programming, turn the radio on while holding the  and  for three seconds.

Talking and Receiving

Signal Strength Indicator/Channel Busy

The radio displays  when activity is on the frequency, and the transmit light flashes at a faster rate of once per second.

When receiving, the display will show  and a signal strength from 1 (weakest) through 5 (strongest). This can help determine when a radio is moving out of range.





Note: Obstacles that block the signal path may affect the strength of the incoming signal.

Talk Range

	Industrial	Multi-Level	Outdoor
Model	Inside steel/concrete industrial buildings	Inside multi-level buildings	Flat ground with no obstructions
UHF 2W	Up to 250,000 Sq. Ft.	Up to 20 Floors	Up to 6 Miles
UHF 1W	Up to 200,000 Sq. Ft.	Up to 15 Floors	Up to 5 Miles
VHF 2W	Up to 180,000 Sq. Ft.	Up to 10 Floors	Up to 6 Miles
VHF 1W	Up to 150,000 Sq. Ft.	Up to 8 Floors	Up to 5 Miles



Keypad Lock

1. To maintain settings and lock keypad, press and hold  for three seconds.
2. To unlock, press and hold  for three seconds.

Hands-Free Use/VOX

Motorola CP100 radios can operate hands-free (VOX) when used with compatible VOX accessories. A short delay occurs between when you start talking and the radio transmits.

With Compatible VOX Accessories





1. Turn radio off.
2. Open accessory cover.
3. Insert plug of audio accessory firmly into accessory jack.
4. Turn radio on. Radio displays: . **If flashing and for initial use, please refer to "Setting Vox Sensitivity" on page 20.**
5. Lower radio volume BEFORE placing accessory near ear.
6. To transmit, speak into accessory microphone and to receive, stop talking.
7. You can disable VOX operation by pressing  or removing the audio accessory.



Note: To order accessories, call 1 (800) 422-4210, or contact your point of purchase.



Without Accessories

You can operate a CP100 15 channel radio hands-free without a VOX accessory.

1. Enable VOX by pressing  while turning the radio on.  displays.
2. You can disable VOX operation temporarily by pressing ,  will flash.
3. A short press of  will re-enable VOX.
4. To disable VOX, turn radio off then back on.

Setting VOX Sensitivity

You can adjust the sensitivity of your radio's accessory or microphone during VOX operation (15 ch models only) to suit different operating environments. These menus appear only if the VOX feature is in use, which is indicated by .

1. Press  until  appears. The radio also displays which VOX sensitivity you are setting:

 = External VOX (with audio accessory)

 = Internal VOX (without accessory; 15 ch models only)

2. Press  or  to select the sensitivity level.

 = Off (VOX with accessories only, default settings)

 = Low sensitivity

 = Medium sensitivity





 = High sensitivity



External VOX

Monitoring a Channel





Check for channel activity.

1. Press and hold . You will hear static if the channel is clear and   will display.
2. Press  again to release.



Scanning (15 ch models only)

You can scan up to 15 channels and frequencies. When the radio detects activity, it stops scanning and locks in on the active channel. This allows you to talk and listen to the person transmitting without changing channels.

1. To start scanning, briefly press . Your radio displays  and begins to scroll through channels. When the radio detects channel activity, it stops on that channel and displays the signal strength indicator and the channel. You can talk to the person(s) transmitting without having to switch channels by pressing . If you press  while the radio is scanning, the radio transmits on the channel you selected before you activated scan.
2. To stop scanning, briefly press .

If no transmission occurs within five seconds, scanning resumes.

To scan a channel without interference eliminator codes, change the code for your set channel to  before you press and release .

Note: When you press , you hear all traffic, but may not be able to transmit back because the other person(s) may be using codes.

Scan Advancement / Nuisance Delete

Scan has several temporary features to make it easier to use.

Scan Advancement allows you to “skip” a busy channel to check for other activity.

- Press  to begin scanning again, but only temporarily.

Nuisance delete allows you to temporarily remove a channel from your scan list, it will return the next time you use the scan feature.

- Press and hold  to temporarily remove a channel from the scan list.

Programming Features

You can change the following features by entering the programming mode (**PROG**). To talk with someone on your two-way radios, these settings must match:

- Channel (15 ch models only)
- Frequency
- Interference Eliminator Code
- Scramble code
- Bandwidth (for optimal clarity)



You can also use **PROG** to set the following:

- Call tones
- Microphone Gain
- Scan List (15 ch models only)
- Available channels (15 ch models only)

Note: You cannot enter **PROG** while a VOX accessory is plugged into the radio.

Entering Programming Mode

You must enter Programming Mode to change your communication settings.

1. Press and hold   for three seconds while turning on your radio. The radio beeps and displays **PROG**.

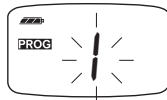

Programming a Channel (15 ch models only)

Each channel has its own Frequency, Interference Eliminator Code, Scramble Code, and Bandwidth Settings.

Program each channel separately.

1. Select the channel that you will be programming.
2. The channel number flashes. **FREQ** and code displays alternately.
3. Press \cup or \cap to select the desired channel.
4. Press and hold PTT to exit **PROG**, or press MENU to continue.



Programming the Frequency





Sets the frequency that your radio will use. As you are matching your CP100 radio to existing SP21 radios, enter Programming Mode as necessary, refer to page 20.

1. Press MENU to display **FREQ**. The frequency flashes.
2. Press \cup or \cap to select the desired frequency (See "Frequencies and Bandwidths" beginning on page 34).
3. Press and hold PTT to exit **PROG**, or press MENU to continue.









Programming the Interference Eliminator Code

The Interference Eliminator Code helps minimize interference by providing you with code combinations, which filter out static, noise, and unwanted messages.

1. Enter Programming Mode as necessary, refer to “Entering Programming Mode” on page 20.
2. Press  until the Interference Eliminator Code display number begins to flash.
3. Press  or  to select the desired Code (See “Interference Eliminator Codes” beginning on page 37).
4. Press and hold  to exit **PROG**, or press  to continue.

Assigning Channels to Presets (15 ch models only)

Presets allow you to easily switch to more frequently-used channels.

1. Enter Programming Mode as necessary, refer to “Entering Programming Mode” on page 20.
2. Press  or  to select the desired channel.
3. Press and hold  or  to assign that channel to a preset, radio beeps to confirm. All of the channel settings are assigned to that preset button.
4. Press and hold  to exit **PROG**, or press  to continue.

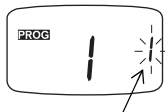







Interference
Eliminator
Code



Programming the Scramble Feature

(2-watt models only)









The scramble feature garbles the transmission for anyone listening without the same scramble setting. It does not guarantee confidentiality, but it increases privacy. The scramble feature is set individually for each channel.

1. Enter Programming Mode as necessary, refer to “Entering Programming Mode” on page 20.
2. Press  until  displays.
3. Press  or  to select 1, 2, or 3. Factory default is set to Off: . When you exit **PROG**,  displays.
4. Press and hold  to exit **PROG**.



Programming Bandwidth (when FCC allowable)

Some frequencies have selectable channel spacing, which must match other radios for optimal radio quality. Bandwidth settings are programmed for each channel.



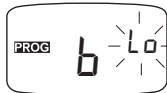

1. Enter Programming Mode as necessary, refer to “Entering Programming Mode” on page 20.
2. Press  until  displays.
3. If  flashes, press  or  to select  (25.0 kHz) or  (12.5 kHz) bandwidth. (See “Frequencies and Bandwidths” beginning on page 37). If  does not flash, then you cannot select the bandwidth for this frequency.
4. Press and hold  to exit **PROG**.



Note: Spirit GT radios operate at 12.5 kHz. SP21 radios may operate at 25.0 kHz or 12.5 kHz bandwidth if selectable. If you have questions on radio use, call 1-800-927-2744.

Programming the Available Channel (15 ch models only)

For applications requiring fewer channels, you can reduce the number of available channels from 15. Older CP100 radios may not have this feature. Call 1-800-927-2744 for more information.

1. Enter Programming Mode as necessary, refer to “Entering Programming Mode” on page 20.
2. Press  until [H] appears.
3. Press  or  to select the number of channels you want available.
4. Press and hold  to exit **PROG**.

Note: Programming settings for channels made unavailable are retained by the radio.

Programming Call Tones

Your radio can transmit call tones to other radios in your group so you can alert them that you are about to talk. The default is set to 0 (off) or you may choose 1, 2, or 3 to choose a distinctive call tone.

1. Enter Programming Mode as necessary, refer to “Entering Programming Mode” on page 20.
2. Press  until [A] displays.



3. Press \cup or \cap to hear and select the call tone you want.

Note: The default is set to \square (off) or you may choose 1 , 2 , or 3 to choose a distinctive call tone.

4. Press and hold $\textcircled{\text{PTT}}$ to exit **PROG**.

Once enabled, press $\textcircled{\text{bell}}$ to transmit the call tone to others.

Programming Microphone Gain

The sensitivity of your radio's microphone can be adjusted to suit different users or operating environments.

1. Enter Programming Mode as necessary, refer to “Entering Programming Mode” on page 23.

2. Press $\textcircled{\text{MENU}}$ until $\textcircled{\text{mic}}$ and \square (Gain) display.

3. Press \cup or \cap to select the sensitivity level.

3 = High sensitivity, for quiet environments

2 = Medium sensitivity, the default setting





1 = Low sensitivity, for loud environments

4. Press and hold $\textcircled{\text{PTT}}$ to exit **PROG**.





Editing the Scan List (15 ch models only)

To avoid hearing transmissions from unnecessary channels while scanning and to decrease scan time, you can edit the scan list to skip unneeded channels.

1. Enter Programming Mode as necessary, refer to “Entering Programming Mode” on page 20.
2. Press  until \rightleftarrows displays and the channel and \mathcal{U} or n flashes.
3. Press  or  to increase or decrease the channel.
4. Press  to display either:
 \mathcal{U} to include the channel
 n to exclude the channel
5. Press and hold  to exit **PROG**.

Cloning

You can duplicate CP100 radio settings from one radio to another by using the optional accessory NNTN4028 Multi-Unit Charger (MUC). Please refer to the MUC User's Guide included with this accessory.

1. To enter the Programming Mode on the source radio, press and hold   for three seconds while turning on your radio. The radio beeps and displays **PROG**.
2. Place the source radio in one of the front pockets of the MUC.

3. Turn on the target radio and place it directly behind the source radio in the MUC.
4. Press and hold **(mon)** on the source radio. The source radio enters Cloning Mode and transmits its settings to the target radio. Either **P** for pass or **F** for fail appears on the source radio and the target radio displays all icons if cloning was successful.
5. Turn the target radio off and back on again to use.
6. To clone additional radios, repeat steps 3 and 5.
7. Exit **PROG** on the source radio by holding down **(P/T)**.

Note: You can clone only one radio at a time.

The MUC does not need to be plugged in for Cloning feature to work. Radios must be of the same band; UHF or VHF. Also, multi-channel models can clone to single-channel radios, but only the first channel is cloned.

Source radio





Target radio



Advanced Features

You can set the following features by pressing and holding additional button(s) **while you turn on your radio.**

To Do This	Press this Key While Turning On the Radio	Default Setting
Turn Keypad Tones on/off You can disable keypad beeps for silent menu operation.	⌋	On
Turn End-of-Transmission Tone on/off When enabled, your two-way radio transmits a tone when you finish transmitting. It's like saying "Roger" or "Over." Note: If Keypad Tones are off, you will not hear the end-of-transmission tone but it is transmitted (if enabled).	⌋+	Off

To Do This	Press this Key While Turning On the Radio	Default Setting
<p>Turn Battery Save on/off</p> <p>Decreases attack time, which is the brief period of time between when the radio receives a transmission on its frequency and broadcasts audio. Turning Battery Save off decreases battery life by approximately 20%.</p>		On
<p>Toggle Phase Shift</p> <p>Changes your phase shift for optimal communication with other Motorola radios.</p> <p>180° CP100 (factory default), Spirit M-Series, and Radius SP21</p> <p>240° Spirit HP and Radius SP50</p>		180°
<p>Restore Factory Defaults</p> <p>Returns your radio to its original factory settings to verify proper operation. Refer to page 14 for factory default settings.</p>		---

Troubleshooting

Symptom	Try This:
No Power	Recharge or replace battery (NTN8971). Reposition or replace alkaline batteries. For Nickel-Metal Hydride batteries, “Installing the Nickel-Metal Hydride Battery” on page 6 or “Battery and Charging Options” on page 11.
Message not transmitted	Make sure  is completely pressed while transmitting. Recharge, replace and/or reposition batteries. Verify the transmit light is illuminated while speaking.
Hearing other noises or conversation on a channel	Frequency or Interference Eliminator Code may be in use, change on all radios if possible. See “Programming the Interference Eliminator Code” on page 22.
Poor Audio Quality	Scramble Code is On (2-watt models only), and/or setting does not match other radios’ settings. See “Programming the Scramble Feature” on page 23. Bandwidth of radios does not match. See “Programming Bandwidth (when FCC allowable)” on page 23.

Symptom	Try This:
Limited talk range	<p>Steel and/or concrete structures, heavy foliage, buildings or vehicles decrease range. Check for clear line of sight to improve transmission. See “Talk Range” on page 15.</p> <p>Wearing radio close to body such as in a pocket or on a belt decreases range. Change location of radio.</p>
Message not received	<p>Confirm radios have the same Channel, Frequency, Interference Eliminator Code and Scramble Code settings, depending upon model. See “Programming Features” on page 20.</p> <p>Recharge, replace and/or reposition batteries.</p> <p>Move to another location. Obstructions and operating indoors, or in vehicles may decrease range.</p> <p>Verify that the radio is not in Scan mode. See “Scanning (15 ch models only)” on page 18.</p>
Heavy static or interference	<p>Radios are too close, they must be at least five feet apart.</p> <p>Radios are too far apart or obstacles are interfering with transmission.</p>
Keypad locked	<p>Unlock by holding  for three seconds.</p>

Symptom	Try This:
Low batteries	Recharge or replace battery or batteries. Extreme operating temperatures affect battery life. See “Battery Life” on page 13.
Charger light does not come on	<p>Reinsert radio/battery.</p> <p>Clean battery/charger contacts.</p> <p>Verify that the charging pin is inserted correctly.</p> <p>AA cells installed in radio, remove and replace with NiMH battery.</p>
Low battery meter reading although new batteries are installed	Verify that the radio is set to the correct battery type (Single-cell batteries only). See “Alkaline Batteries” on page 11.
Cannot activate VOX	<p>Feature not set and on. See “Hands-Free Use/VOX” on page 16.</p> <p>Sensitivity set to . See “Setting VOX Sensitivity” on page 17.</p>
Cannot enter PROG mode	Unplug any audio accessories and retry.

Use and Care



Use a soft damp cloth to clean the exterior.



Do not immerse in water.



Do not use alcohol or cleaning solutions.

If the radio is submerged in water...



Turn radio off and remove batteries.



Dry with soft cloth.



Do not use radio until completely dry.

Frequencies and Bandwidths

The charts on the next few pages provide frequency information. These charts are useful when using Motorola CP100 two-way radios with other business radios. Frequency Display Number is identical to SP21 and Spirit GT frequency position (where applicable).

VHF Frequencies

Display Number	Frequency (MHz)	Bandwidth
1	151.6250	12.5/25.0
2	151.9550	12.5/25.0
3	154.5700	12.5/25.0
4	154.6000	12.5/25.0
5	151.6550	12.5/25.0
6	151.6850	12.5/25.0
7	151.7150	12.5/25.0
8	151.7750	12.5/25.0
9	151.8050	12.5/25.0
10	151.8350	12.5/25.0
11	151.8950	12.5/25.0
12	151.9250	12.5/25.0
13	154.4900	12.5/25.0
14	154.5150	12.5/25.0
15	154.5400	12.5/25.0

Display Number	Frequency (MHz)	Bandwidth
16	158.4000	12.5/25.0
17	151.7000	25.0
18	151.7600	25.0
19	151.5125	12.5/25.0
*20	151.8200	12.5/25.0
*21	151.8800	12.5/25.0
*22	151.9400	12.5/25.0
23	151.5125	25.0
24	151.7450	25.0
25	152.8650	25.0
26	152.7000	25.0
27	154.5275	25.0

***Note:** Due to FCC regulations, these frequencies transmit at only 1 watt.

UHF Frequencies

Display Number	Frequency (MHz)	Bandwidth
1	464.5000	12.5/25.0
2	464.5500	12.5/25.0
3	467.7625	12.5/25.0
4	467.8125	12.5/25.0
5	467.8500	12.5/25.0
6	467.8750	12.5/25.0
7	467.9000	12.5/25.0
8	467.9250	12.5/25.0
9	462.5750	12.5/25.0
10	462.6250	12.5/25.0
11	462.6750	12.5/25.0
12	464.3250	12.5/25.0
13	464.8250	12.5/25.0
14	469.2625	12.5/25.0

Display Number	Frequency (MHz)	Bandwidth
15	469.5000	12.5/25.0
16	469.5500	12.5/25.0
17	462.7625	12.5
18	462.7875	12.5
19	462.8125	12.5
20	462.8375	12.5
21	462.8625	12.5
22	462.8875	12.5
23	462.9125	12.5
24	464.4875	12.5
25	461.0375	12.5
26	461.0625	12.5
27	461.0875	12.5
28	461.1125	12.5

UHF Frequencies (Continued)

Display Number	Frequency (MHz)	Bandwidth
29	461.1375	12.5
30	461.1625	12.5
31	461.1825	12.5
32	461.2125	12.5
33	461.2375	12.5
34	461.2625	12.5
35	461.2875	12.5
36	461.3125	12.5
37	461.3375	12.5
38	461.3625	12.5
39	462.7625	12.5
40	462.7875	12.5
41	462.8125	12.5
42	462.8375	12.5

Display Number	Frequency (MHz)	Bandwidth
43	462.8625	12.5
44	462.8875	12.5
45	462.9125	12.5
46	464.4875	12.5
47	464.5125	12.5
48	464.5375	12.5
49	464.5625	12.5
50	466.0375	12.5
51	466.0625	12.5
52	466.0875	12.5
53	466.1125	12.5
54	466.1375	12.5
55	466.1625	12.5
56	466.1875	12.5

Interference Eliminator Codes

Display Number	Code (Hz)
1	67.0
2	71.9
3	74.4
4	77.0
5	79.7
6	82.5
7	85.4
8	88.5
9	91.5
10	94.8
11	97.4
12	100.0
13	103.5

Display Number	Code (Hz)
14	107.2
15	110.9
16	114.8
17	118.8
18	123.0
19	127.3
20	131.8
21	136.5
22	141.3
23	146.2
24	151.4
25	156.7
26	162.2

Display Number	Code (Hz)
27	167.9
28	173.8
29	179.9
30	186.2
31	192.8
32	203.5
33	210.7
34	218.1
35	225.7
36	233.6
37	241.8
38	250.3

Carrier Squelch (0) disables interference eliminator codes.

Digital Interference Eliminator Codes

Display Number	Digital Code
39	023
40	025
41	026
42	031
43	032
44	043
45	047
46	051
47	054
48	065
49	071
50	072
51	073
52	074
53	114

Display Number	Digital Code
54	115
55	116
56	125
57	131
58	132
59	134
60	143
61	152
62	155
63	156
64	162
65	165
66	172
67	174
68	205

Display Number	Digital Code
69	223
70	226
71	243
72	244
73	245
74	251
75	261
76	263
77	265
78	271
79	306
80	311
81	315
82	331
83	343

Digital Interference Eliminator Codes (Continued)







Display Number	Digital Code
84	346
85	351
86	364
87	365
88	371
89	411
90	412
91	413
92	423
93	431
94	432
95	445
96	464

Display Number	Digital Code
97	465
98	466
99	503
100	506
101	516
102	532
103	546
104	565
105	606
106	612
107	624
108	627
109	631

Display Number	Digital Code
110	632
111	654
112	662
113	664
114	703
115	712
116	723
117	731
118	732
119	734
120	743
121	754

Verifying the SP21 Frequency and Code Setting

The CP100 Two-Way radio replaces the SP21 radio. The factory default settings for both radios are identical. However, existing radios may have been programmed to different settings. To program your CP100 radio to talk with an SP21 radio, verify or change your SP21 frequency and code settings as follows.

1. Press and hold  while you turn on the radio to enter programming mode.
The radio announces current frequency for that channel. For example: "frequency one."
2. If desired, press  to scroll through the frequencies.
The radio announces each frequency as you scroll. For example: "two...three..."
3. Release  when you reach the desired frequency.
4. Press  to select and save the frequency setting.
The radio announces current code setting. For example: "code two nine"
5. Press  to scroll through the codes.
The radio announces each code as you scroll. For example: "three zero...three one"
6. Release  when you reach the desired code.
7. Press  to select and save the code setting.

Motorola Limited Warranty

Personal Communications Products Purchased in the United States and Canada

I. What this Warranty Covers

- Products. Defects in materials and workmanship in wireless cellular telephones, pagers, and/or two-way radios, and certain accessories that are sold with them, such as the battery, battery charger and holster manufactured and/or sold by Motorola (Products).
- Batteries. Defects in materials and workmanship in batteries that are manufactured by Motorola and/or sold with Products are covered by this warranty only if the fully-charged capacity falls below 80% of rated capacity or they leak.
- Software. Physical defects in the media that tangibly embodies each copy of any software supplied with the Products.

II. What the Period of Coverage Is

From the date the Products are purchased by the first end-user:

- Products. The warranty is for one year. Exception: The warranty for Spirit GT series and Talkabout series two-way radio accessories is for 90 days.
- Software. The warranty is for 90 days.
- Repairs / Replacements. The warranty is for the balance of the original warranty or for 90 days from the date you receive it, whichever is longer.

III. Who Is Covered

This warranty extends to the first end-user purchaser, only.

IV. What We Will Do to Correct Warranty Problems

At no charge to you, we have the option to repair or replace the Products or software that do not conform to the warranty, or to refund the Products' purchase price. We may use functionally equivalent reconditioned/refurbished/pre-owned or new Products or parts. No software updates are provided.

V. How to Get Warranty Service

Please call:

USA/Canada

Product Services 1-800-927-2744

Two-Way 1-800-353-2729

TTY 1-888-390-6456

(Text Telephone)

You will receive instructions on how to ship the Products to Motorola. You must ship the Products to us with freight, duties and insurance prepaid. Along with the Products you must include: (a) a copy of your receipt, bill of sale or other comparable proof of purchase; (b) a written description of the problem; (c) the name of your service provider (if this Product requires subscription service); (d) the name and location of the installation facility (if applicable) and, most importantly; (e) your address and telephone number. If requested, you must also return all detachable parts such as antennas, batteries and chargers. **RETAIN YOUR ORIGINAL PROOF OF PURCHASE.**

We will ship repaired or replacement Products at our expense for the freight and insurance, but at your expense for any duties. If additional information is needed, please contact us at the telephone number listed above.

VI. What this Warranty Does Not Cover

- Products that are operated in combination with ancillary or peripheral equipment or software not furnished by Motorola for use with the Products (“ancillary equipment”), or any damage to the Products or ancillary equipment as a result of such use. Among other things, “ancillary equipment” includes batteries, chargers, adaptors, and power supplies not manufactured or supplied by Motorola. Any of these voids the warranty.
- Someone other than Motorola (or its authorized service centers) tests, adjusts, installs, maintains, alters, modifies or services the Products in any way. Any of these voids the warranty.
- Rechargeable batteries that: (a) are charged by other than the Motorola-approved battery charger specified for charging such batteries; (b) have any broken seals or show evidence of tampering; (c) are used in equipment other than the Product for which they are specified; or (d) are charged and stored at temperatures greater than 60 degrees centigrade. Any of these voids the warranty.
- Products that have: (a) serial numbers or date tags that have been removed, altered or obliterated; (b) board serial numbers that do not match each other, or board serial numbers that do not match the housing; or (c) nonconforming or non-Motorola housings or parts. Any of these voids the warranty.
- Defects or damage that result from: (a) use of the Products in a manner that is not normal or customary; (b) improper operation or misuse; (c) accident or neglect such as dropping the Products onto hard surfaces; (d) contact with water, rain, extreme humidity or heavy perspiration; (e) contact with sand, dirt or the like; or (f) contact with extreme heat, or spills of food or liquid.
- Physical damage to the surface of the Products, including scratches, cracks or other damage to a display screen, lens or other externally exposed parts.
- Failure of Products that is due primarily to any communication service or signal you may subscribe to or use with the Products.
- Coil cords that are stretched or that have any broken modular tabs.
- Products that are leased.

Flat-rate repair rates may apply to Products not covered by this warranty. To obtain information about Products needing repairs that are not covered by this warranty, please call the telephone number previously listed. We will provide information on repair availability, rates, methods of payment, where to send the Products, etc.

VII. Some Other Limitations

This is Motorola's complete warranty for the Products, and states your exclusive remedies. This warranty is given in lieu of all other express warranties. Implied warranties, including without limitation, the implied warranties of merchantability and fitness for a particular purpose, are given only if specifically required by applicable law. Otherwise, they are specifically excluded.

No warranty is made as to coverage, availability, or grade of service provided by the Products, whether through a service provider or otherwise.

No warranty is made that the software will meet your requirements or will work in combination with any hardware or applications software products provided by third parties, that the operation of the software products will be uninterrupted or error free, or that all defects in the software products will be corrected.

In no event shall Motorola be liable, whether in contract or tort (including negligence) for damages in excess of the purchase price of the Product, or for any indirect, incidental, special or consequential damages of any kind, or loss of revenue or profits, loss of business, loss of information or data, or other financial loss arising out of or in connection with the ability or inability to use the Products, to the full extent these damages may be disclaimed by law.

VIII. Patent and Software Provisions

At Motorola's expense, we will defend you, and pay costs and damages that may be finally awarded against you, to the extent that a lawsuit is based on a claim that the Products directly infringe a United States patent. Our obligation is conditioned on: (a) you notifying us promptly in writing when you receive notice of the claim; (b) you giving us sole control of the defense of the suit and all negotiations for its settlement or compromise; and (c) should the Products become, or in Motorola's opinion be likely to become, the subject of a claim of infringement of a United States patent, you permit us, at our option and expense, either to: procure for you the right to continue using the Products; replace or modify them so that they become non-infringing; or grant you a credit for such Products, as depreciated, and accept their return. The depreciation will be an equal amount per year over the lifetime of the Products, as established by Motorola.

Motorola will have no liability to you with respect to any claim of patent infringement that is based upon the combination of the Products or parts furnished under this limited warranty with ancillary equipment, as defined in VI., above.

This is Motorola's entire liability with respect to infringement of patents by the Products.

Laws in the United States and other countries preserve for Motorola and other third party software providers certain exclusive rights for copyrighted software, such as the exclusive rights to reproduce in copies and distribute copies of such software. The software may be copied into, used in and redistributed with only those Products that are associated with such software. No other use, including without limitation, disassembly or reverse engineering of such software or exercise of exclusive rights in such software is permitted.

IX. State Law and Other Jurisdiction Rights

Some states and other jurisdictions do not allow the exclusion or limitation of incidental or consequential damages, or limitation on the length of an implied warranty, so the above limitations or exclusions may not apply to you.

This warranty gives you specific legal rights, and you may also have other rights, which vary from jurisdiction to jurisdiction.

To obtain information on Motorola Personal Communications Products, including warranty service, accessories and optional Extended Warranties on selected Products, please call:

Product Services 1-800-927-2744 All Products 1-800-461-4575

Software Copyright Notice

The Motorola products described in this manual may include copyrighted Motorola and third party software stored in semiconductor memories or other media. Laws in the United States and other countries preserve for Motorola and third party software providers certain exclusive rights for copyrighted software, such as the exclusive rights to distribute or reproduce the copyrighted software. Accordingly, any copyrighted software contained in the Motorola products may not be modified, reverse-engineered, distributed, or reproduced in any manner to the extent allowed by law. Furthermore, the purchase of the Motorola products shall not be deemed to grant either directly or by implication, estoppel, or otherwise, any license under the copyrights, patents, or patent applications of Motorola or any third party software provider, except for the normal, non-exclusive, royalty-free license to use that arises by operation of law in the sale of a product.

Patent Notice

This product is covered by one or more of the following United States patents.

5896277 5894292 5864752 5699006 5742484 D408396 D399821 D387758
D389158 5894592 5893027 5789098 5734975 5861850 D395882 D383745
D389827 D389139 5929825 5926514 5953640 6071640 D413022 D416252
D416893 D433001

Export Law Assurances

This product is controlled under the export regulations of the United States of America and Canada. The Governments of the United States of America and Canada may restrict the exportation or re-exportation of this product to certain destinations. For further information contact the U.S. Department of Commerce or the Canadian Department of Foreign Affairs and International Trade.

Replacement of any transmitter component (crystal, semiconductor, etc.) not authorized by the FCC equipment authorization for this radio could violate FCC rules. More specifically, changes or modifications not expressly approved by Motorola may void the user's authority granted by the FCC to operate this radio and should not be made. To comply with FCC requirements, transmitter adjustments should be made only by or under the supervision of a person certified as technically qualified to perform transmitter maintenance and repairs in the private land mobile and fixed services as certified by an organization representative of the user of those services. Replacement of any transmitter component (crystal, semiconductor, etc.) not authorized by the FCC equipment authorization for this radio could violate FCC rules.

Note: Use of this radio outside the country where it was intended to be distributed is subject to government regulations and may be prohibited

Replacement Parts

The following items can be purchased if necessary by contacting the Customer Care and Services Division at 800-422-4210.

Part Number	Description
NNTN4105	Battery Cover
NNTN4106	Swivel Belt Holster
3685739D01	Volume Knob
6804112599	CP100 User Guide



- A**
 Audio accessories16
 Adjust volume8, 9
 Advanced features28
 Alkaline batteries11
- B**
 Bandwidth23
 Basic operations9
 Battery
 Alkaline11
 Install11
 Charge
 Alkaline12
 NiMH12
 Meter13
- C**
 Call display24
 Channel
 Activity18
 Charger
 Drop-in12
 Multi-unit26
- Plug-in7
 Charging7
 Cloning26
 Code
 Interference eliminator22
- D**
 Diagram
 Function9
 Drop-in charger12
- E**
 End-of-transmission tone28
 External VOX16, 32
- F**
 FCC licensing information3
 Frequency
 Setting21
 Functions9
- H**
 Hands-free use16, 32

I		O	
Install		Obstacles	15
Alkaline batteries	11	Operating radio.....	9
NiMH battery	6	P	
Interference eliminator code.....	22	Plug	
Internal VOX.....	16, 32	Audio.....	16
Introduction	1	Plug-in charger.....	7
K		Product-related questions	2
Keypad tones	28	Product Safety.....	i
L		Programming mode.....	20
Licensing information		R	
FCC	3	Radio	
M		Clean	33
Meter		Diagram	9
Battery	10	Display	13
Microphone gain.....	28, 25	Functions and settings.....	9
Monitor signal strength.....	10, 15	Off	8
		On	8
		Operating	9
		Out of range	15, 31
		Range	
		Talking	15
		Replacement Parts.....	49

RF Exposure.....	i	U	
S		Use and care	33
Safety information.....	i	User guide	
Scan	18	Large-print.....	2
Scan list.....	26	V	
Sensitivity	17, 25	VOX	
Setting		External	16
Battery type	11	Internal	17
Call tone	24	Sensitivity level.....	17
Channel.....	21	W	
Scramble code	23	Warranty	41
VOX sensitivity level.....	17, 25	Website	
Signal strength indicator	15	Accesories.....	i
T			
Talk range.....	15		



CP100 Programming Quick Reference

Function Appearance

Press & hold   for 3 sec. and turn on radio. **PROG** displays.

***Channel**



Use  or  for 1 through 15.

Frequency



Press  until **FREQ** displays. To change, press  or .

*depending upon model

*depending upon model



**Interference
Eliminator
Code**



Appears after **FREQ** shows. Set for each channel.



***Scramble
Code**



Press  until  displays. Must be set to same code for all radios.

Bandwidth



Press  until **b** displays. Press  or  to select **H** (25.0 kHz) or **L** (12.5 kHz).



Note: If bandwidth is not flashing, it is not selectable on the chosen frequency.

CP100 Programming Quick Reference

Radio On Visual  as needed, then  or 

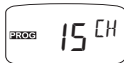
***Available Channels**



Press  until **CH** displays.
Press  or  to select number of available channels.

Call Tone



Choose **1**, **2**, **3**, or
0 = Off (default).



Microphone Gain



Choose:
1 Low Sensitivity
2 Medium Sensitivity
3 High Sensitivity

***Scan List**



Press  or  to select channel,
then choose **Y** (yes) to include or
n (no) to exclude by pressing .

*depending upon model



- **Extend Your Productivity**
Provides a cost-effective solution to onsite communication needs. Designed for heavy duty, everyday industrial use. Well suited for construction, manufacturing, security, property management, retail, and more.
- **Rugged MOTOROLA Quality**
Shock/drop/temperature tested to meet Motorola's high standards.
- **Weather/Dust Resistant**
Designed to meet IP-54 rating
- **Designed to meet Military Specs**
810 C, D, E & F
- **Dependable Indoor/Outdoor Coverage**
Will provide a communication range* of up to 250,000 sq. ft. or 20 floors and up to 6 miles.
*Range will vary based on terrain and conditions and model selected.
- **Accessories for CP100 Radio**
Brochure included - Convenient audio, power and charging accessories are available from your point-of-sale
- **Simple and Easy to Operate**
Allows one-to-one or group communication at the push of a button.
- **Cost Efficient**
No monthly fees to pay and no service contracts. Compatible with Motorola SP21 radios and audio accessories.
- **Cloning Capability**
- **Business Exclusive Frequencies**
Frequencies set aside exclusively for business-only use. FCC License is required.
- **38 PL Codes, 83 Digital PL Codes**
- **Hands-Free Mode (VOX)**
Advanced voice activation (VOX) lets you talk hands-free; 15-Channel models do not require accessories.
- **Voice Compression Technology**
Helps provide better sound at longer distances.
- **1-Year Limited Warranty**
For details, please call: 1-800-927-2744

Radio Specification Chart

Transmit Power	2 Watts
Receiver Sensitivity	-120 dBm for 12 dB SINAD
Audio Output	90 dB SPL
Receiver Technology	Direct Conversion
NiMH Battery Life	Approximately 13 hrs 2W

MOTOROLA, The Stylized M logo, and Radius are registered in the US Patent & Trademark Office. All other product or service names are the property of their respective owners. © Motorola, Inc. 2002, 2003. All rights reserved. Printed in the U.S.A.

Motorola CP100 Radio



6804112J99-A

Proof of Purchase

**FCC
License Required**



**WARNING CHOKING HAZARD
SMALL PARTS**

Not for children under 3 years.
This product is not intended to be used
as a toy or plaything.